

SERVICE MANUAL

PARTS LIST

MODEL **AM-2200**

AKAI

SECTION 1

SERVICE MANUAL

TABLE OF CONTENTS

I.	TECHNICAL DATA	2
II.	DISMANTLING OF UNIT	3
III.	CONTROLS	4
IV.	PRINCIPAL PARTS LOCATION	4
V.	LEVEL DIAGRAM	5
VI.	MAIN AMP ADJUSTMENT.....	5
VII.	CLASSIFICATION OF VARIOUS P.C BOARDS.....	6
	1. RELATION OF P.C BOARD TITLE AND IDENTIFICATION NUMBER	6
	2. COMPOSITION OF VARIOUS P.C BOARD	7

For basic adjustments measuring methods, and operating principles, refer to GENERAL OPERATING PRINCIPLES AND ADJUSTMENTS.

I. TECHNICAL DATA

1. Power Amplifier Section

Continuous Power Output	20 watts per channel, minimum RMS, at 8 ohms from 20 to 20,000 Hz with no more than 0.5% total harmonic distortion
POWER BANDWIDTH (1HF)	10 to 45,000 Hz/8 ohms (Total Harmonic Distortion 0.5%)
SIGNAL TO NOISE RATIO (1HF)	Phono: Better than 85 dB Aux: Better than 95 dB
RESIDUAL NOISE	Less than 0.8 mV at 8 ohms
CHANNEL SEPARATION (1HF)	Phono: Better than 55 dB at 1,000 Hz
DAMPING FACTOR	More than 60 (1 kHz, 8 ohms)
OUTPUT	Speakers: A,B (4 to 16 ohms)/A+B(8 to 16 ohms) Headphone: 4 to 16 ohms

2. Pre Amplifier Section

INPUT SENSITIVITY AND IMPEDANCE	Phono: 3 mV/47 k ohms AUX: 150 mV/100 k ohms Tuner: 150 mV/100 k ohms Tape Monitor: PIN; 150 mV/100 k ohms DIN; 150 mV/100 k ohms
OUTPUT LEVEL AND IMPEDANCE	Tape REC: PIN; 150 mV/100 k ohms DIN; 150 mV/100 k ohms
FREQUENCY RESPONSE	Phono (RIAA equalization) 30 to 15,000 Hz ± 1 dB
TONE CONTROL	BASS: ± 9 dB at 100 Hz, TREBLE: ± 7 dB at 10 kHz
LOUDNESS CONTROL	+10 dB at 100 Hz, +5 dB at 10 kHz (Volume Control set at -30 dB position)
FILTER	HIGH: -6 dB at 10 kHz, LOW: -6 dB at 50 Hz

3. Others

SEMICONDUCTORS	Transistors: 18, Diodes: 5, IC: 1
POWER REQUIREMENTS	U.S.A. and Canada model: 120V, 60 Hz CEE models: 220V, 50 Hz Other models: 110/220/240V, 50/60 Hz switchable
DIMENSIONS	380(W) x 125(H) x 263(D) mm (15 x 4.9 x 10.3) inches
WEIGHT	5.5 kg (12.1 lbs.)

NOTE: For improvement purposes, specifications and design are subject to change without notice.

II. DISMANTLING OF UNIT

In case of trouble, etc. necessitating disassembly, please disassemble in the order shown in photograph. Reassemble in reverse order.

1



SCREWS

5

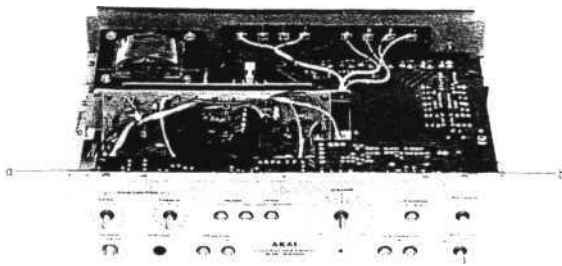

SCREWS

2

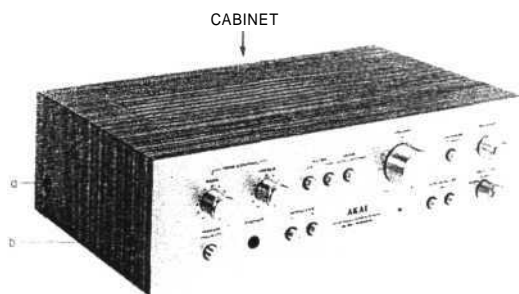

SCREWS

6

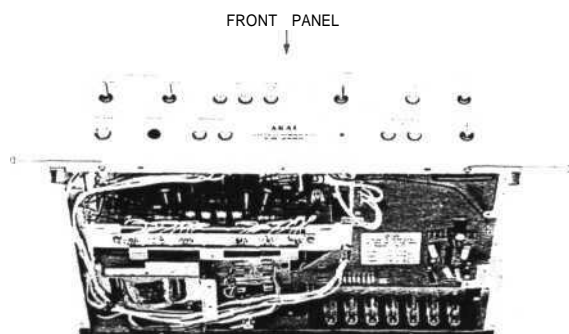

SCREWS

3

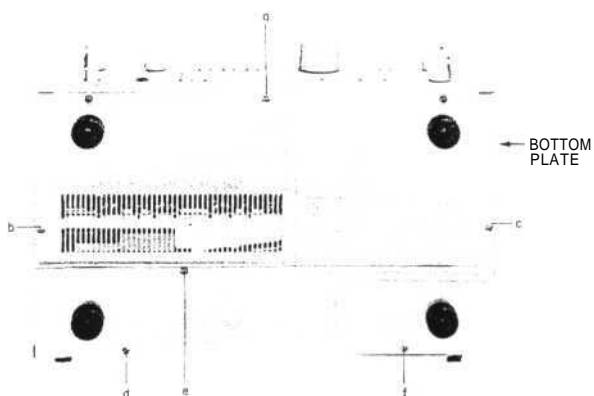

SCREWS

7

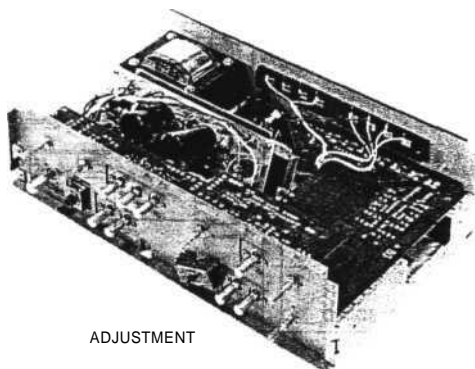

ADJUSTMENT

4

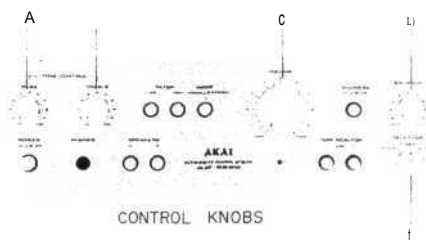

CONTROL KNOBS

III. CONTROLS

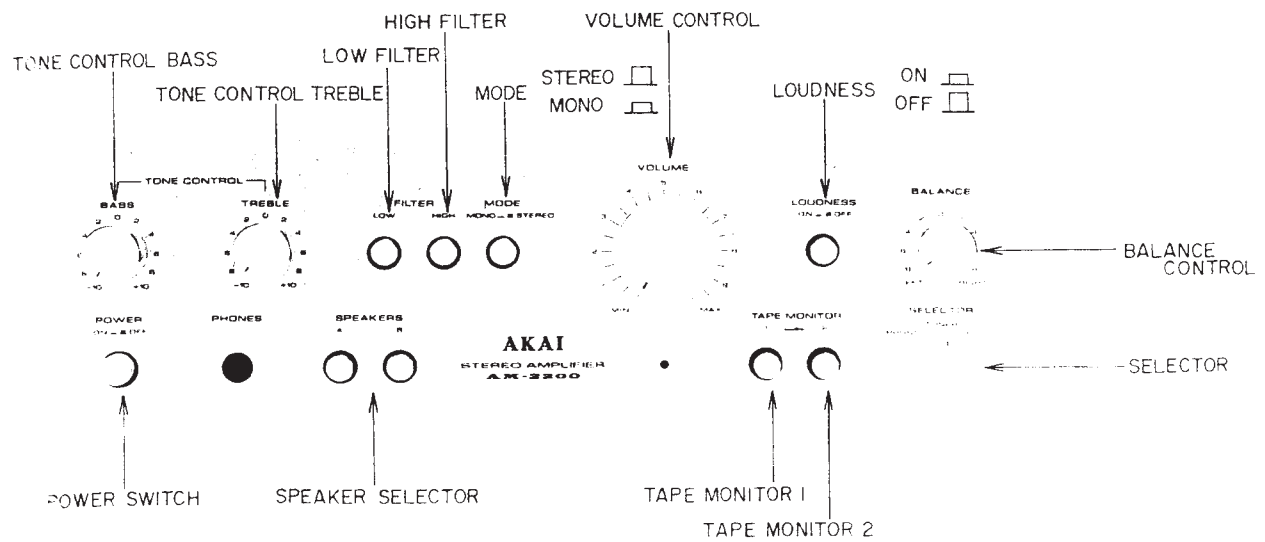

Fig. 1 Controls

IV. PRINCIPAL PARTS LOCATION

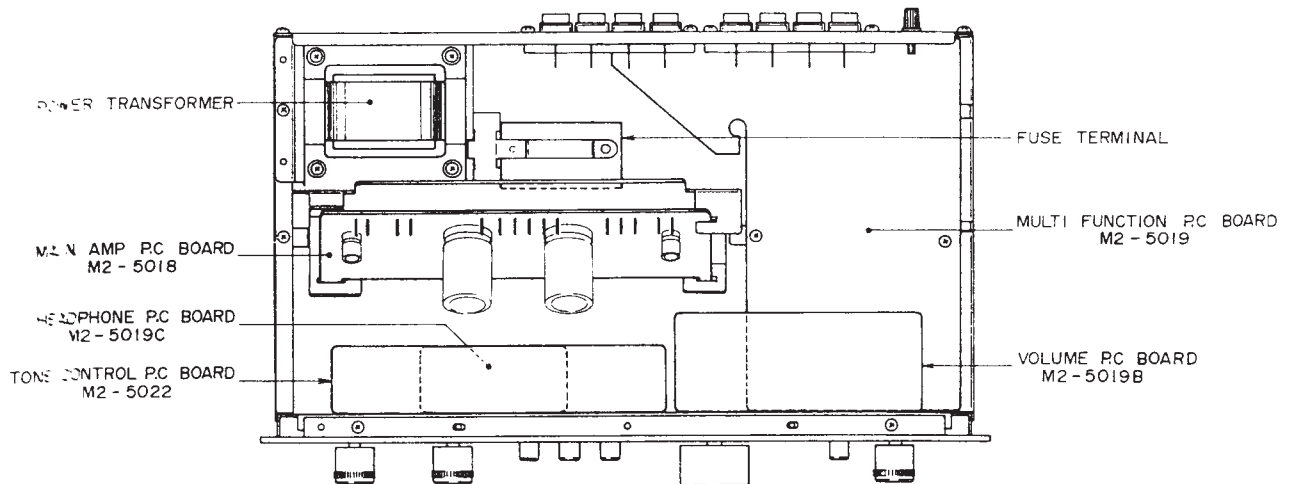

Fig. 2 Top View

V. LEVEL DIAGRAM

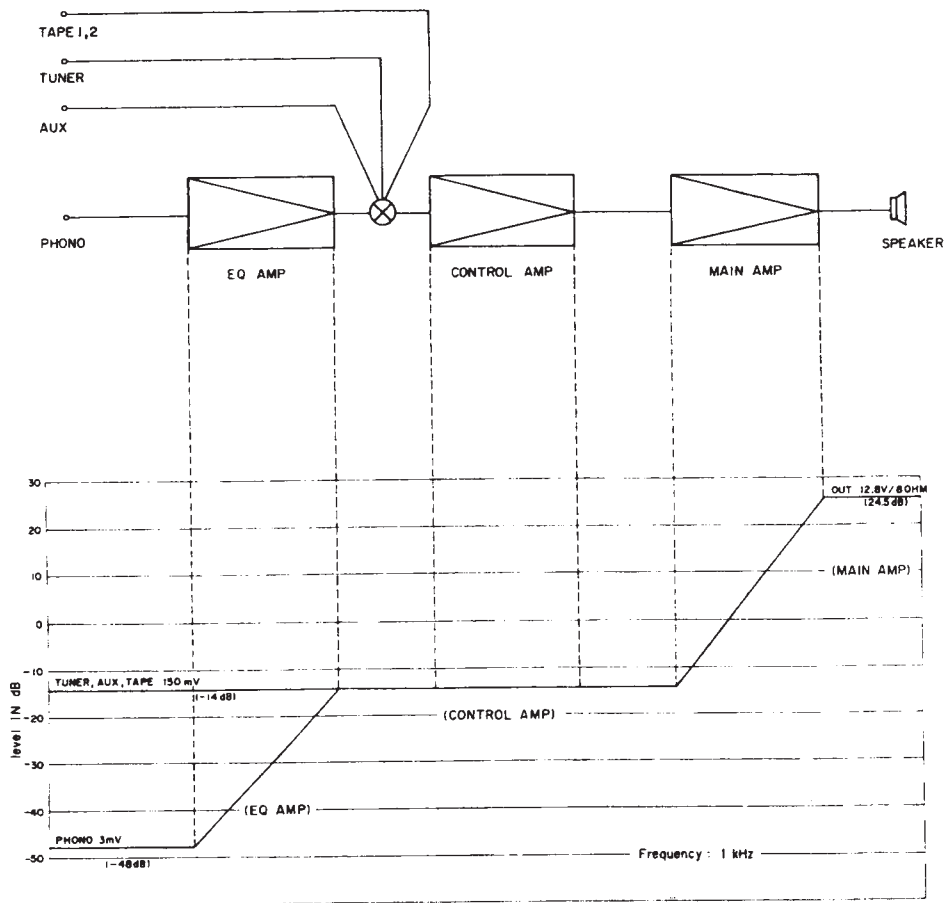

Fig. 3 Level Diagram of Model AM-2200

VI. MAIN AMP ADJUSTMENT

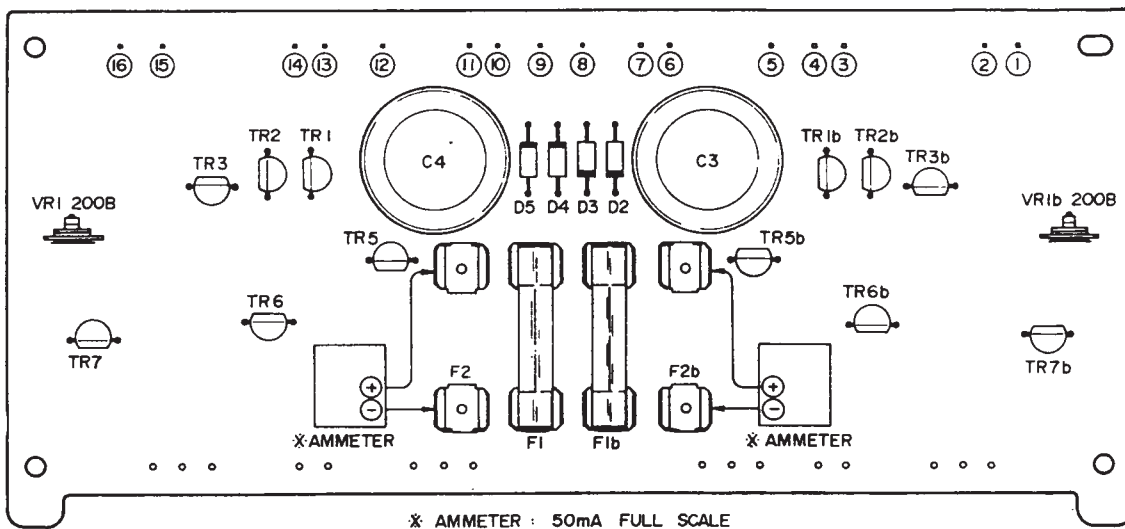

Fig. 4 Main Amp P.C Board M2-2018

Idling Current Adjustment (Refer to Fig. 4)

1. Disconnect \oplus current Fuse F2 2A and connect Ammeter.
2. At non-signal input, adjust semi-fixed resistor VR1

VII. CLASSIFICATION OF VARIOUS P. C BOARDS

1. RELATION OF P.C BOARD TITLE AND IDENTIFICATION NUMBER

P.C Board	Number of P.C Board
Main Amp P.C Board	M2-5018/A
MFC P.C Board	M2-5019
LED P.C Board	M2-5019A
VR P.C Board	M2-5019B
Headphone P.C Board	M2-5019C
Tone Control P.C Board	M2-5022

2. COMPOSITION OF VARIOUS P.C BOARD

1) MAIN AMP P.C BOARD M2-5018/A, LED P.C BOARD M2-5019A

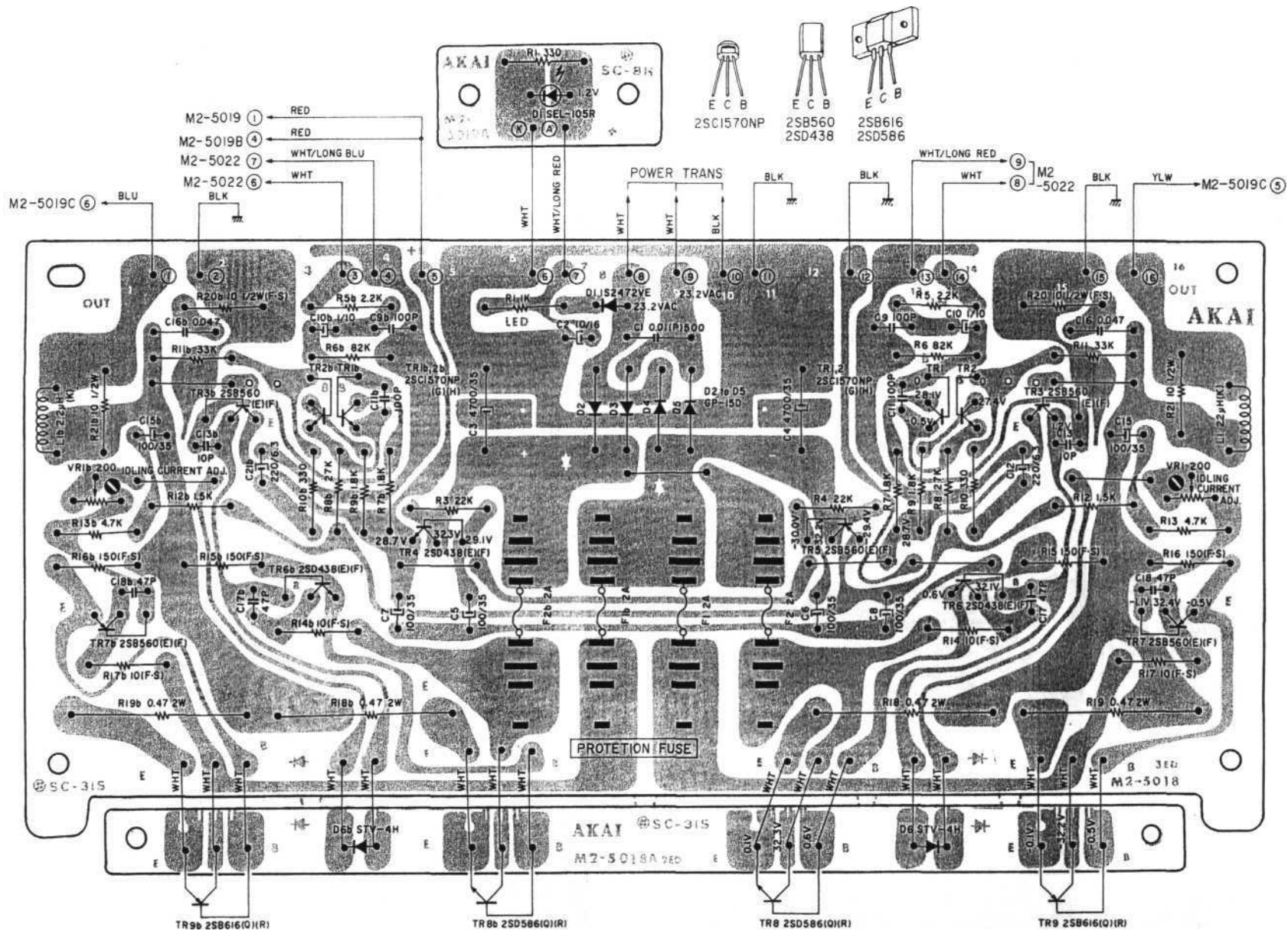

3) VR P.C BOARD M2-5019B

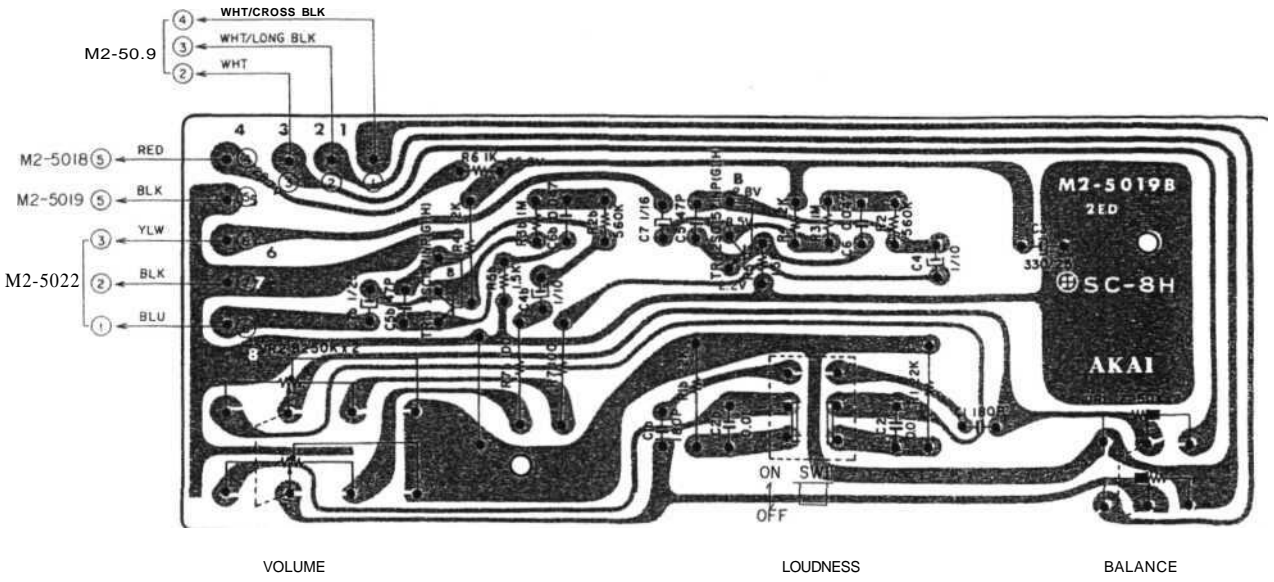

4) HEADPHONE P.C BOARD M2-5019C

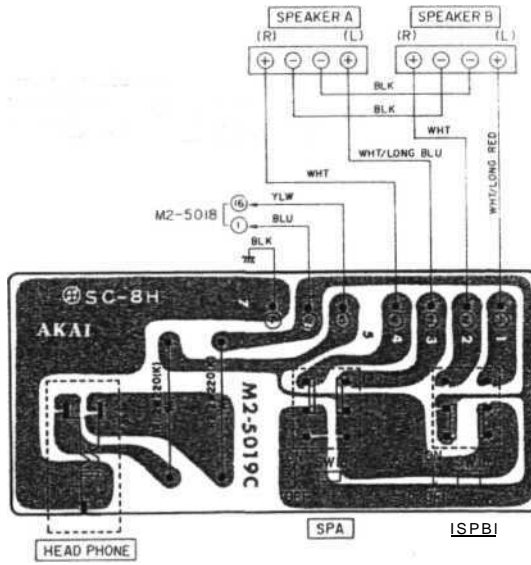

5) TONE CONTROL P.C BOARD M2-5022

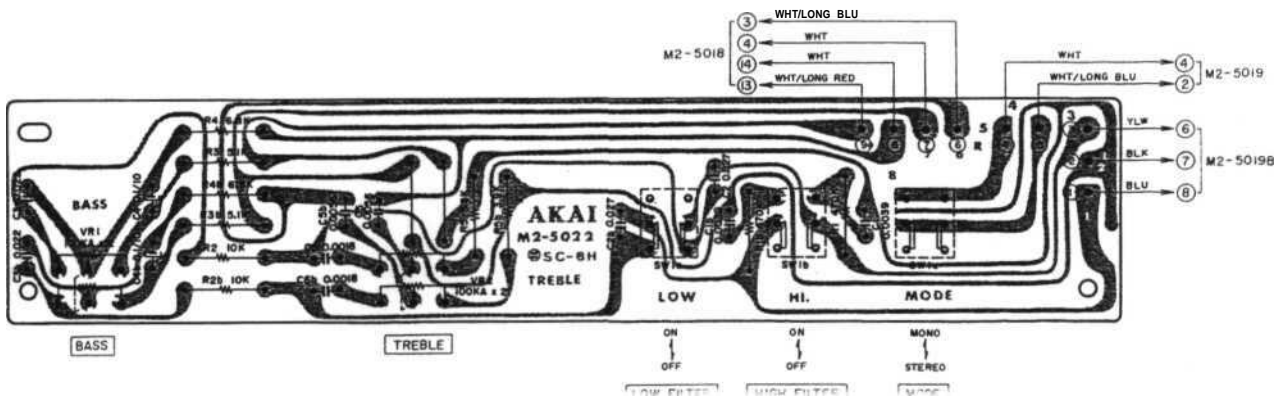

2) MFC P.C BOARD M2-5019

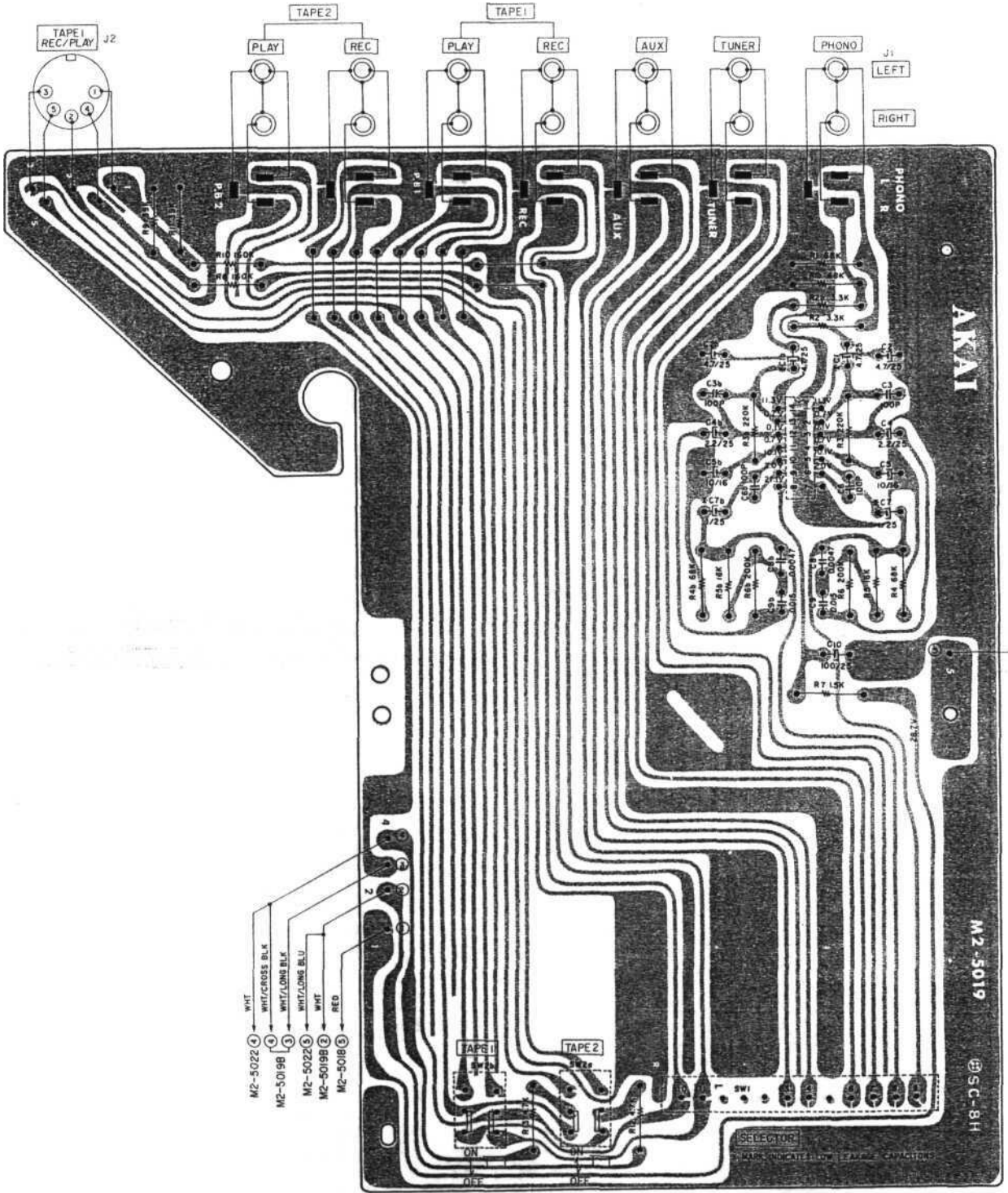

[TAPE MONITOR]

SECTION 2

PARTS LIST

TABLE OF CONTENTS

1. RECOMENDED SPARE PARTS LIST	17
2. MAIN AMP P.C BOARD (M2-5018) BLOCK.....	18
3. MFC P.C BOARD (M2-5019) BLOCK	18
4. VOL P.C BOARD (M2-5019B) BLOCK.....	18
5. HEADPHONE P.C BOARD (M2-5019C) BLOCK.....	18
6. TONE CONTROL P.C BOARD (M2-5022) BLOCK	18
7. ASSEMBLY BLOC.....	19
8. FINAL ASSEMBLY BLOCK.....	21
9. LIST OF JNTERCHANGEABLE SEMICONDUCTORS	22
INDEX	23

Resistor and Capacitor which is not listed in this parts list, please refer to COMMON LIST FOR SERVICE PARTS.

HOW TO USE THIS PARTS LIST

1. This parts list is compiled by various individual blocks based on assembly process.
2. When ordering parts, please describe parts number, serial number, and model number in detail.
3. How to read list.

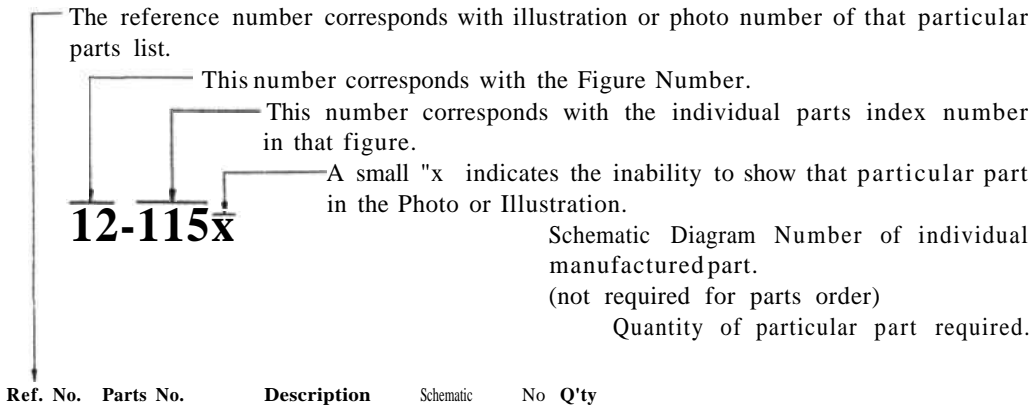

Ref. No.	Parts No.	Description	Schematic	No	Q'ty
FLYWHEEL BLOCK #13					
12-115x	800425	Flywheel Block Assy. Comp.	RD6#13		
12-116	244506	Flywheel Only	RD 233		
12-117x	244754	Felt, Flywheel	RD275		
12-118	251324	Main Metal Case	RD 236		
12-119	253080	Main Metal	RD237		

4. The symbol numbers shown on the P.C. Board list can be matched with the Composite Views of components of the Schematic Diagram or Service Manual.
5. The indications of Resistors and Capacitors in the photos of P.C. Board are being eliminated.
6. The shape of the parts and parts name, etc. can be confirmed by comparing them with the parts shown on the Electrical Parts Table of P.C. Board.
7. Both the kind of part and installation position can be determined by the Parts Number. To determine where a parts number is listed, utilize Parts Index at end of Parts List.
It is necessary first of all to find the Parts Number. This can be accomplished by using the Reference Number listed at right of parts number in the Parts Index, (meaning of ref. no. outlined in Item 3 above).
8. Utilize separate "Price List for Parts" to determine unit price. The most simple method of finding parts Price is to utilize the reference number.

CAUTION:

1. When placing an order for parts, be sure to list the parts no. model no., and description. There are instances in which if any of this information is omitted, parts cannot be shipped or the wrong parts will be delivered.
2. Please be careful not to make a mistake in the parts no. If the parts no. is in error, a part different from the one ordered may be delivered.

1. RECOMMENDED SPARE PARTS LIST

Parts No.	Parts Nomenclature	Reference No.
BA211263	Multi Function P.C Board Comp. M2-5019	
BA211252	Main Amp P.C Board Comp. M2-5018	
BA211274	Volume P.C Board Comp. M2-5019B	
BA211285	Headphone P.C Board Comp. M2-5019C	
BA211432	Tone Control P.C Board Comp. M2-5022	
BC224807	Cabinet A M2-5013	
BD211230	Front Panel Block Comp. AM-2200(U)	
BT225178	Power Transformer AM-2200T-1	
BT215043	Power Transformer AM-2200T-2	CSA
BT215054	Power Transformer AM-2200T-3	CEE
BT239591	Power Transformer AM-2200T-4	BEAB
ED656357	Luminous Diode SEL105R	
ED551733	Silicon Varistor STV-4H	
ED656278	Silicon Diode 1S2472VE	
ED219903	Silicon Diode GP15D	
EI697871	IC LA3122	
EJ650272	Pin Jack 14P JPJ379-1-1	J1 (Multi Function P.C Board)
EJ698051	Din Jack	J2 (Multi Function P.C Board)
EJ225022	Headphone Jack LJ255-1-12	J1 (Headphone P.C Board)
EJ240581	Push Terminal 4P	
E0650823	Phase Equalizer Coil 2.2μH	L1 (Main Amp P.C Board)
ES225055	Rotary Switch SR26N C30K	SW1 (Multi Function P.C Board)
ES225088	Push Switch 2F-0005FF3220	SW2 (Multi Function P.C Board)
ES224965	Push Switch 1FT-0004AF4920	SW1 (Volume P.C Board)
ES225044	Push Switch 2F-0002FF1620	SW1 (Headphone P.C Board)
ES219846	Push Switch 3FT-0001FF6820	
ES224436	Power Switch JP01	SW1 (Power Switch)
ES239218	Power Switch JP01 (TV-4)	CSA
ES242346	Power Switch JP- 17	CEE
ET219870	Transistor 2SD586 (Q)(R)	
ET219881	Transistor 2SB616 (Q)(R)	
ET223446	Transistor 2SC1571NP (G)(H)	
ET219868	Transistor 2SB560 (E)(F)	
ET219857	Transistor 2SD438 (E)(F)	
ET539987	Transistor 2SC1312R (F)(G)	
EV573366	Semi-fixed Volume V10K8-4-2 200 ohmsB	VR1 (Main Amp P.C Board)
EV224943	Single axial 2-throw Volume V24L5G 3BM 250kx2	VR1 (Volume P.C Board)
EV224954	Single axial 2-throw Volume V16L4G 31Z 250kx2	VR2 (Volume P.C Board)
EV219835	Single axial 2-throw Volume V16L4 15A 100kx2	VR1 ,2 (Tone Control P.C Board)
SK224886	Power Knob M2-5021	
SK646817	Single Knob AA-5250	
SK634410	Push Button Knob J 91-5051	
SK225090	Volume Knob M2-5015	
SP224662	Rear PanelA M2-5010	
SZ645243	Circular Foot A CA-6014	

2. MAIN AMP P.C BOARD (M2-5018) BLOCK

Symbol No.	Parts No.	Description	Q'ty
2-1	BA211252	Main Amp P.C Board Comp. (M2-5018)	1
2-2	BA270764	Main Amp P.C Board Comp. (M2-S018XCEE)	1
2-3	BA27077S	Main Amp P.C Board Comp. (MS-S018)(CSA)	1
2-TR1.2	ET245790	Transistor 2SC1570NP (G)(H)	4
2-TR3	ET219868	Transistor 2SB560 (E)(F)	2
2-TR4	ET219857	Transistor 2SD438 (E)(F)	1
2-TRS	ET219868	Transistor 2SB560 (E)(F)	1
2-TR6	ET219857	Transistor 2SD438 (E)(F)	2
2-TR7	ET219868	Transistor 2SB560 (E)(F)	2
2-D1	ED656278	Silicon Diode 1S2472	1
2-D2 to 5	ED219903	Silicon Diode GP15D	4
2-VR1	EV245823	Semi-fixed/Vol. V10K8-1-2 200 ohmsB	2
2-L1	E0650823	Phase Equalizer Coil 2.2 μ H(K)	2
2-4	EA233932	Transistor P.C Board (M2-5018A)	1
2-5	EA233943	Transistor P.C Board A (M2-5018A)(CSA)	1
2-6	EJ514822	Fuse Holder, P.C Board S-N5051	8
2-7	EJ592503	Fuse Clip, P.C Board H0426 (CEE)	8
2-R18.19	ER219914	Metal Oxide Film/R. 2W 0.47 ohms (K)	4
2-C10	EC557155	Solid Aluminum/C. 1 μ F(M) 10WV(Vert. Type)	2
2-C13	EC474671	FM/C. 10PF(K) 500WV	2

3. MFC P.C BOARD (M2-5019) BLOCK

Symbol No.	Parts No.	Description	Q'ty
3-1	BA211263	Multi Function P.C Board Comp. (M2-5019)	1
3-IC1	E1697871	1C LA-3122	1
3-SW2	ES225088	Push SW. 2F-0005FF3220	1
3-J1	EJ650272	Pin Jack 14P JPJ379-1-1	1
3-J2	EJ698051	Din Jack	1

4. VOL P.C BOARD (M2-5019B) BLOCK

Symbol No.	Parts No.	Description	Q'ty
4-1	BA211274	Vol P.C Board Comp. (M2-S019B)	1
4-TR1	ETS39987	Transistor 2SC1312R(F)(G)	2
4-VR1	EV224943	Single axial 2 throw Vol. V24L5G 3BM 250kx2	1
4-VR2	EV224954	Single axial 2 throw Vol. V16L4G 31Z 250kx2	1
4-SW1	ES224965	Push SW. 1FT-0004AF4920	1
4-C4	EC5S7155	Solid Aluminum/C. 1 μ F(M) 10WV (Vert. Type)	2
4-C7	EC223413	Solid Aluminum/C. 1 μ F(M) 16WV (Vert. Type)	2

5. HEADPHONE P.C BOARD (M2-5019C) BLOCK

Symbol No.	Parts No.	Description	Q'ty
5-1	BA21128S	Headphone P.C Board Comp. (M2-S019C)	1
S-J1	EJ225022	Headphone Jack	1
S-SW1	ES22S044	Push SW. 2F-0002FF1620	1
5-R1.2	ER409814	Metal Oxide Film/R. 2W 220 ohms (K)	2

6. TONE CONTROL P.C BOARD (M2-5022) BLOCK

Symbol No.	Parts No.	Description	Q'ty
6-1	BA211432	Tone Control P.C Board Comp. (M2-5022)	1
6-VR1.2	EV219835	Single axial 2 throw Vol. V16L4 20A 100kx2	2
6-SW1	ES219846	Push SW. 3FT-0001FF6820	1
6-C4	EC219813	Solid Aluminum/C. 0.1 μ F(M) 10WV (Vert. Type)	2

ROM

7. PHOTO OF ASSEMBLY BLOCK

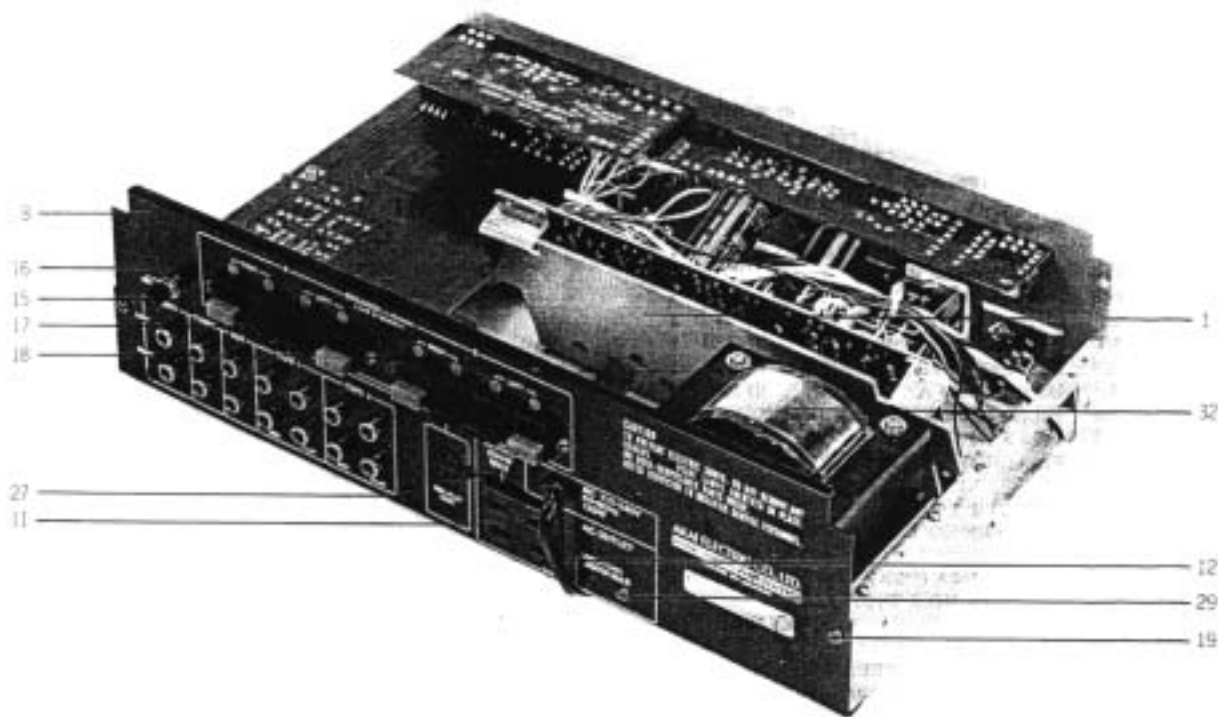
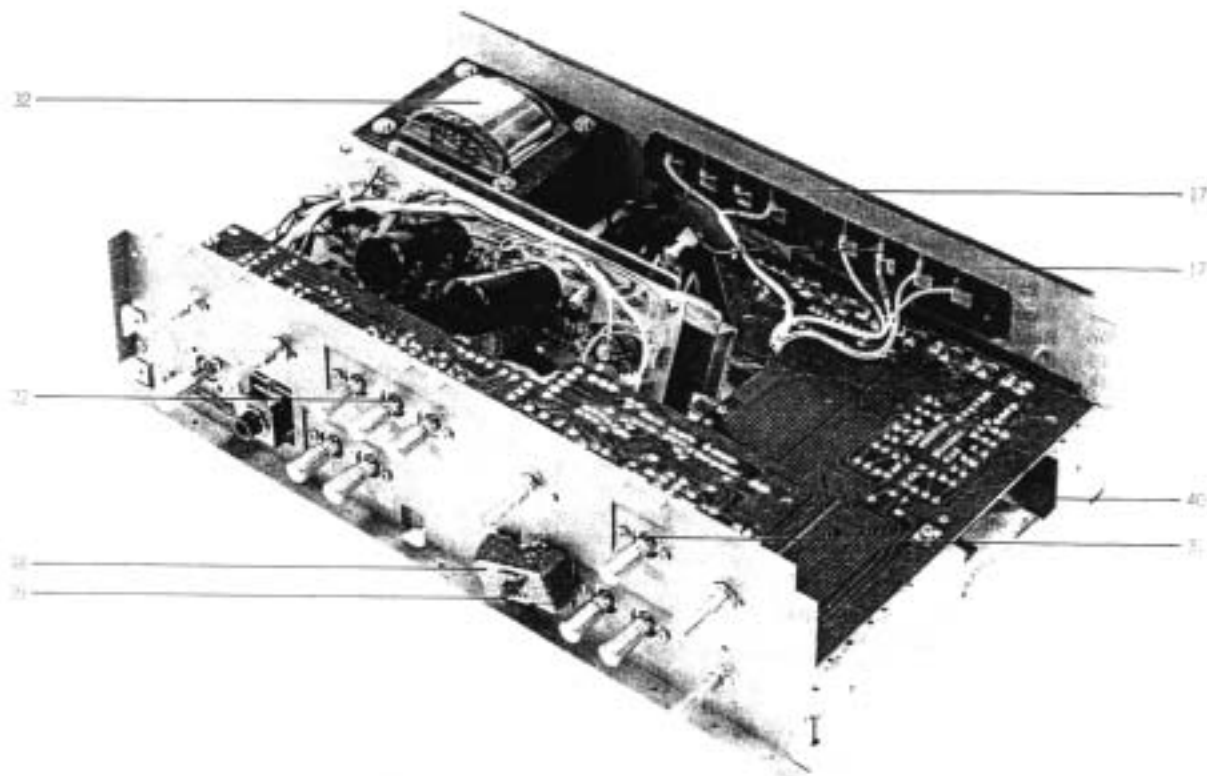

7.) ASSEMBLY BLOCK

Ref. No.	Parts No.	Description	Schematic No.	Qty.	Symbol No	Parts No.	Description	Schematic
					7-S6x	MZ229138	Wire Bundle Holder N-108 (CEE, CSA)	2-35-1
					7-S7x	ZS447840	Tapping Screw #2 3x8 (BR) (CEE, CSA)	1
HEAT-SINK BLOCK								
7-1	BZ211241	Heat-sink Block Comp.		1				
7-2x	ET219870	Transistor 2SD586 (Q)(R)	45-1-236	2				
7-3x	ET219881	Transistor 2SB616 (Q)(R)	45-1-237	2				
7-4x	ZS379350	Screw, pan head 3x6		8				
7-Sx	ED551733	Varistor STV-4H	45-10-10	2				
7-6x	ZS608332	Screw, pan head 3x8, w/washer		2				
7-7x	ZS447840	Tapping Screw #2 3x8(BR)		4				
REAR PANEL BLOCK								
7-8	EZ224662	Rear Panel A	M2-5010	1				
7-9x	EZ224706	Rear Panel B (CSA)	M2-5010	1				
7-10x	EZ224717	Rear Panel C (CEE)	M2-5010	1				
7-11	EZ225145	2 throw AC Outlet	31-1-166	1				
7-12	EW540123	AC Cord (CUL) 2.5M	26-3-20	1				
7-1 3x	EW604S85	AC Cord BSI	26-3-37	1				
7-14	EZ631945	Strain Relief SR-4N-4	2-7-49	1				
7-15	SK652397	Knob OS12-2	34-1-4	1				
7-16	ZW652408	Washer (SPC) D3.2x10x0.5t		1				
7-17	EJ240581	4P Push Terminal	32-1-72	2				
7-18	ZS52286S	Tapping Screw #2 3x12(BR)		4				
ASSEMBLY BLOCK								
7-19	ZS32S495	Tapping Screw #2 3x6 (BR)		9				
7-20x	ZS379350	Screw, pan head 3x6		11				
7-21x	ZW273802	Toothed Lock Washer M3		1				
7-22	ES224436	Push SW, JP01	25-5-221	1				
7-2 3x	ES242346	Push SW, JP17 (CEE)	25-5-224	1				
7-24x	ES239218	Push SW, JP01(TV-4) (CSA)	25-5-222	1				
7-25x	EC684720	Ceramic/C. CLD16YE 0.01μF(P) 500WV	24-5-61	1				
7-26x	ECS65896	Ceramic/C. DP6600YM 0.01μF(P) 1.4 kWV (CSA)	24-5-58	1				
7-27	ZW698308	Nylon Rivet (FNPR) 3x5.5 (Black)	2-7-54	4				
7-28x	ZW239578	Nylon Rivet (FNPR) 4x5 (Black) (CEE, CSA)	2-7-58	1				
7-29	ZS447761	Tapping Screw #2 3x6 (BR) (Black)		1				
7-30x	EJ214975	3P Fuse Holder (Large) B (Lugging Type)	40-1-104	1				
7-31	ES225055	Rotary SW, SR26N C30K	25-6-95	1				
7-32	BT225178	Power Trans. AM-2200T-1	38-4-433	1				
7-33x	BT215054	Power Trans. AM-2200T-3 (CEE)	38-4-447	1				
7-34x	BT215043	Power Trans. AM-2200T-2 (CSA)	38-4-446	1				
7-35x	ZW273914	Spring Washer M4		4				
7-36x	ZW413188	Nut M4, #1		4				
7-37x	EJ551035	Wrapping Terminal, 4P T-S251	32-1-36	2				
7-38	EA224515	LED P.C Board	M2-5019A	1				
7-39	ED656357	LED SEL-105R	45-15-11	1				
7-40	SP224831	Bottom Plate A	M2-5014	1				
7-41 x	ZS447840	Tapping Screw #2 3x8 (BR)		5				
7-42 x	EF277413	Fuse ST-2 2A	39-1-26	4				
7-43x	EF607550	Fuse (SEMKO T Type) 1.2SAT 250V (CEE)	39-1-53	1				
7-44x	EF332098	Fuse ST-1 2A (CSA)	39-1-25	1				
7-45 x	EF690996	Fuse (SEMKO T Type) 4AT (CEE)	39-1-53	2				
7-46x	EF552846	Fuse ST-1 4A (CSA)	39-1-25	2				
7-47x	EF623103	Fuse (SEMKO T Type) 1AT (CEE)	39-1-53	4				
7-48x	EF563703	Fuse 2A250V	39-1-50	1				
7-49x	TA239567	Wire Band Plate (CEE.CSA)	M2-5024	1				
7-50x	EJ239580	Fuse Holder, w/sticker AM-2S (CEE)	40-1-141	1				
7-51x	EJ239477	Fuse Holder, w/sticker AM-2L(CSA)	40-1-119	1				
7-52x	ZW273881	Earth Lug M4 (CEE)		1				
7-53x	ZW273892	Toothed Lock Washer M4 (CEE)		1				
7-54x	ZW413188	Nut M4 #1(CEE)		1				

When ordering parts, please describe Parts Number, Descriptor, and Model Number in detail

8. PHOTO OF FINAL ASSEMBLY BLOCK

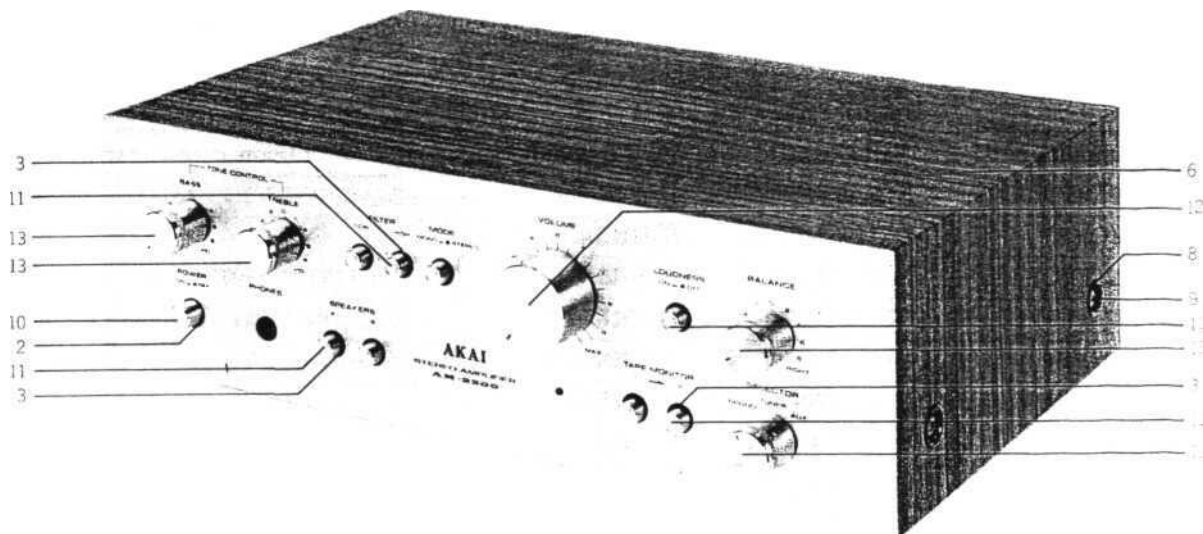

8.5) FINAL ASSEMBLY BLOCK

Ref. No.	Parts No.	Description	Schematic No.	Q'ty
FRONT PANEL BLOCK				
8-1x	BD211230	Front Panel Block Comp.		
8-2	MZ224627	Push Button Bush A	M2-5004	1
8-3	SE613888	Button Escutcheon A	CW-6021	8
ASSEMBLY BLOCK				
8-4x	SZ64S243	Circular Foot A	CA-6014	4
8-5x	ZS214997	Tapping Screw, #2 4x6 pan		4
8-6	BC224807	Cabinet A	M2-5013	1
8-7x	BC266782	Cabinet C (CSA)	M2-5013	1
8-8	ZW548010	Spot Facing Washer	MU-6028	4
8-9	ZS510344	Screw, binding head 4x12		4
8-10	SK224886	Power Knob	M2-5021	1
8-11	SK634410	Push Button Knob J	91-5051	8
8-12	SK22S090	Vol. Knob	M2-5015	1
8-13	SK646817	Single Knob	AA-5250	4

9. LIST OF INTERCHANGEABLE SEMICONDUCTORS

As far as service is concerned, in case the original parts cannot be obtained, the interchangeable parts listed below can be substituted.

Original Parts			Interchangeable Parts	
Description	Parts No.	Utilizing P.C Board	Description	ParteNo.
2SB560(E)(F)	ET2 19868	M2-5018	2SA815(O)(Y)	ET649078
2SB616(Q)(R)	ET2 19881	M2-8018A		
2SC1312(F)(G)	ET539987	M2-5019B	2SC1571NP(G)(H)	ET223446
2SC1517NP(G)(H)	ET223446	M2-5018	2SC1312(F)(G)	ET539987
2SD438(E)(F)	ET2 19857	M2-5018	2SC1625(O)(Y)	ET649067
2SD586(Q)(R)	ET2 19870	M2-5018A		
LA3122	EI697871	M2-5019		
1S2472VE	ED656278	M2-5018	1S2472	ED656278
GP15D	ED2 19903	M2-5018	1R5BZ61	ED650621
SEL105R	ED656357	M2-5019A		
STV-4H	ED551733			

INDEX

Parts No.	Ref. No. & Symbol No.	Parts No.	Ref. No. & Symbol No.	Parts No.	Ref. No.	No	Parts No.	Ref. No. & Symbol No.	Ref. No. & Symbol No.
BA211252	2-1	SK224886	8-10						
BA211263	3-1	SK225090	8-12						
BA211274	4-1	SK634410	8-11						
BA211285	5-1	SK646817	8-13						
BA211432	6-1	SK652397	7-15						
BA270764	2-2	SP224831	7-40						
BA27077S	2-3	SZ645243	8-4x						
BC224807	8-6	TA239567	7-49x						
BC266782	8-7x	ZS214997	8-5x						
BD211230	8-1x	ZS32549S	7-19						
BT215043	7-34x	ZS379350	7-4x						
BT21S054	7-33x	ZS379350	7-20x						
BT225178	7-32	ZS417150	7-S5x						
BZ211241	7-1	ZS447761	7-29						
EA224515	7-38	ZS447840	7-7x						
EA233932	2-4	ZS447840	7-41x						
EA233943	2-5	ZS447840	7-57x						
EC219813	6-C4	ZS510344	8-9						
EC223413	4-C7	ZS522865	7-18						
EC474671	2-C13	ZS608332	7-6x						
EC557155	2-C10	ZW239578	7-28x						
EC557155	4-C4	ZW273802	7-21x						
EC565896	7-26x	ZW273881	7-52x						
EC684720	7-25x	ZW273892	7-53x						
ED219903	2-D2to5	ZW273914	7-35x						
ED551733	7-5x	ZW413188	7-36x						
ED656278	2-D1	ZW413188	7-54x						
ED656357	7-39	ZW548010	8-8						
EF277413	7-42x	ZW652408	7-16						
EF332098	7-44x	ZW698308	7-27						
EF552846	7-46x								
EF563703	7-48x								
EF602550	7-43x								
EF623103	7-47x								
EF690996	7-45x								
EI697871	3-IC1								
EJ214975	7-30x								
EJ225022	5J1								
EJ239477	7-51x								
EJ239580	7-S0x								
EJ240581	7-17								
EJ5 14822	2-6								
EJ551035	7-37x								
EJ592503	2-7								
EJ650272	3-J1								
EJ698051	3-J2								
EO650823	2-L1								
ER219914	2-R18.19								
ER409814	5-R1.2								
ES219846	6-SW1								
ES224436	7-22								
ES224965	4-SW1								
ES225044	5-SW1								
ES225055	7-31								
ES225088	3-SW2								
ES239218	7-24x								
ES242346	7-23x								
ET219857	2-TR4								
ET219857	2-TR6								
ET219868	2-TR3								
ET219868	2-TR5								
ET2 19868	2-TR7								
ET219870	7-2x								
ET2 19881	7-3x								
ET24S790	2-TR1.2								
ET539987	4-TR1								
EV219835	6-VR1.2								
EV224943	4-VR1								
EV224954	4-VR2								
EV245823	2-VR1								
EW540123	7-12								
EW604S85	7-13x								
EZ224662	7-8								
EZ224706	7-9x								
EZ224717	7-10x								
EZ225145	7-11								
EZ631945	7-14								
MZ224627	8-2								
MZ229138	7-56x								
SE613888	8-3								

ROM

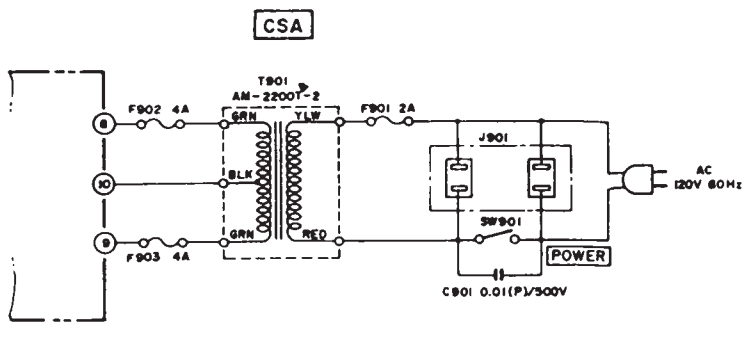
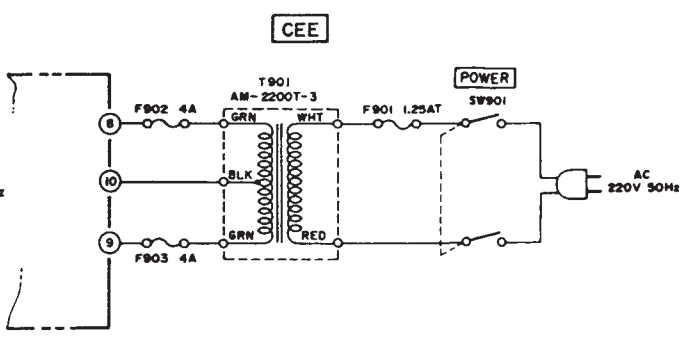
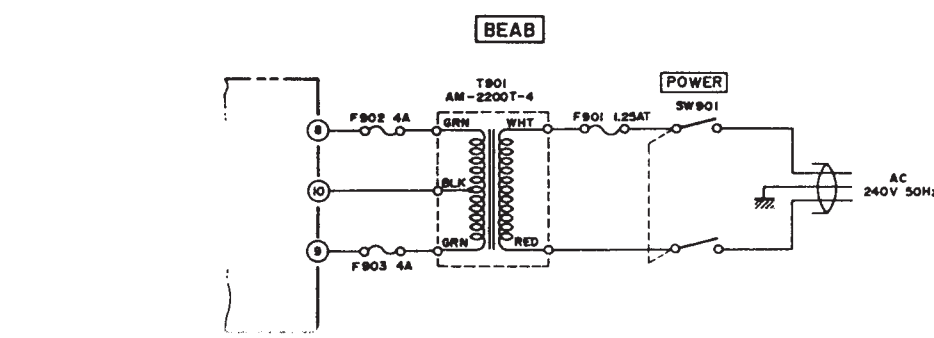
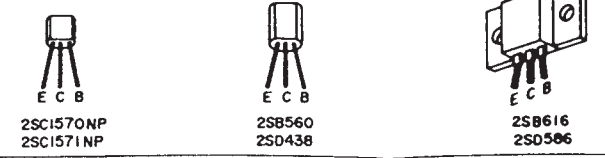
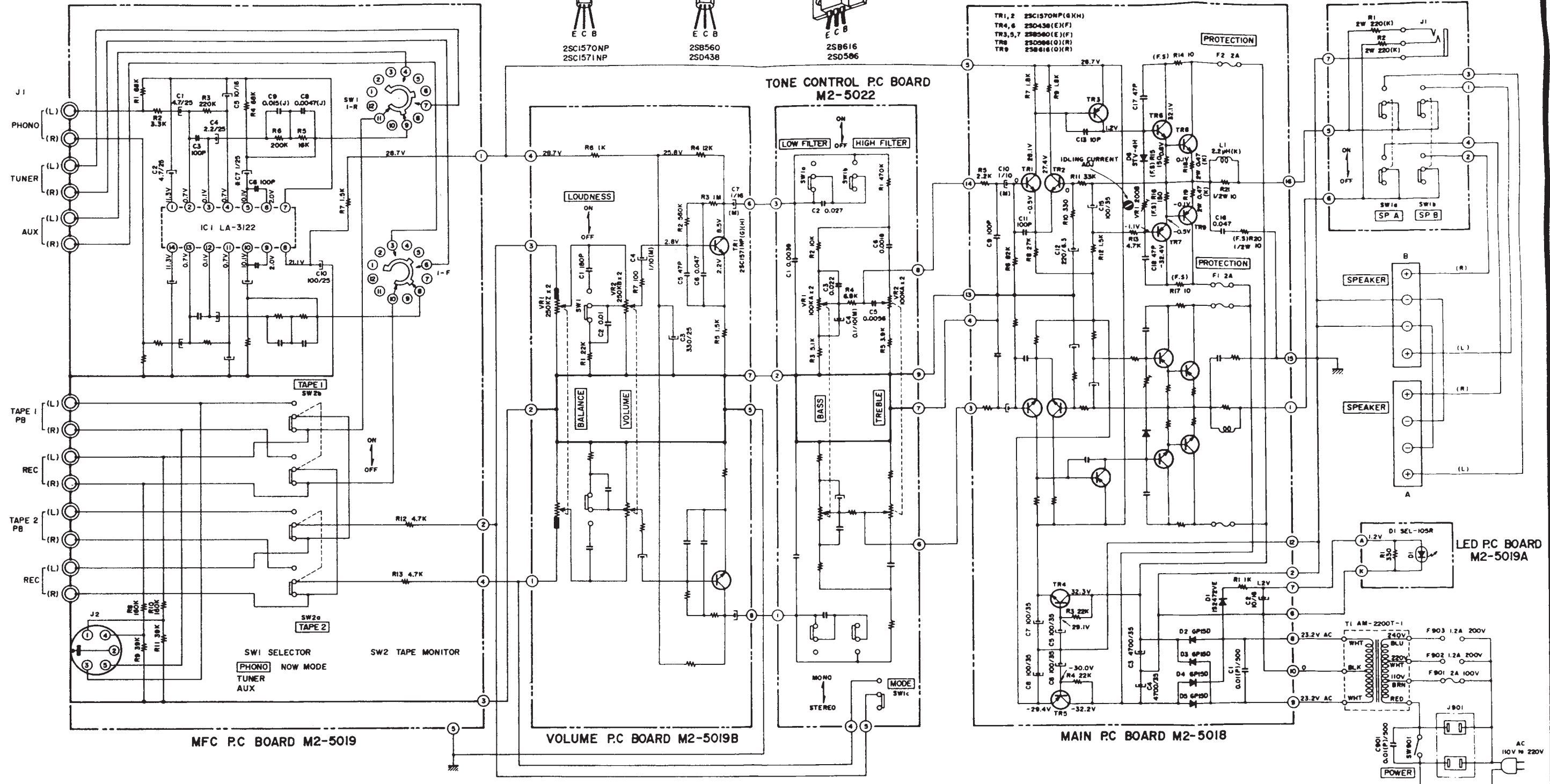

NOTE
UNLESS OTHERWISE SPECIFIED
ALL RESISTORS IN 1/4W (J)
ALL CAPACITORS IN 50WV(K)
Z MARK INDICATES LOW LEAKAGE CAPACITORS

COMPOSITION OF VARIOUS P.C BOARD

MAIN AMP P.C BOARD M2-5018/A, LED P.C BOARD M2-5019A

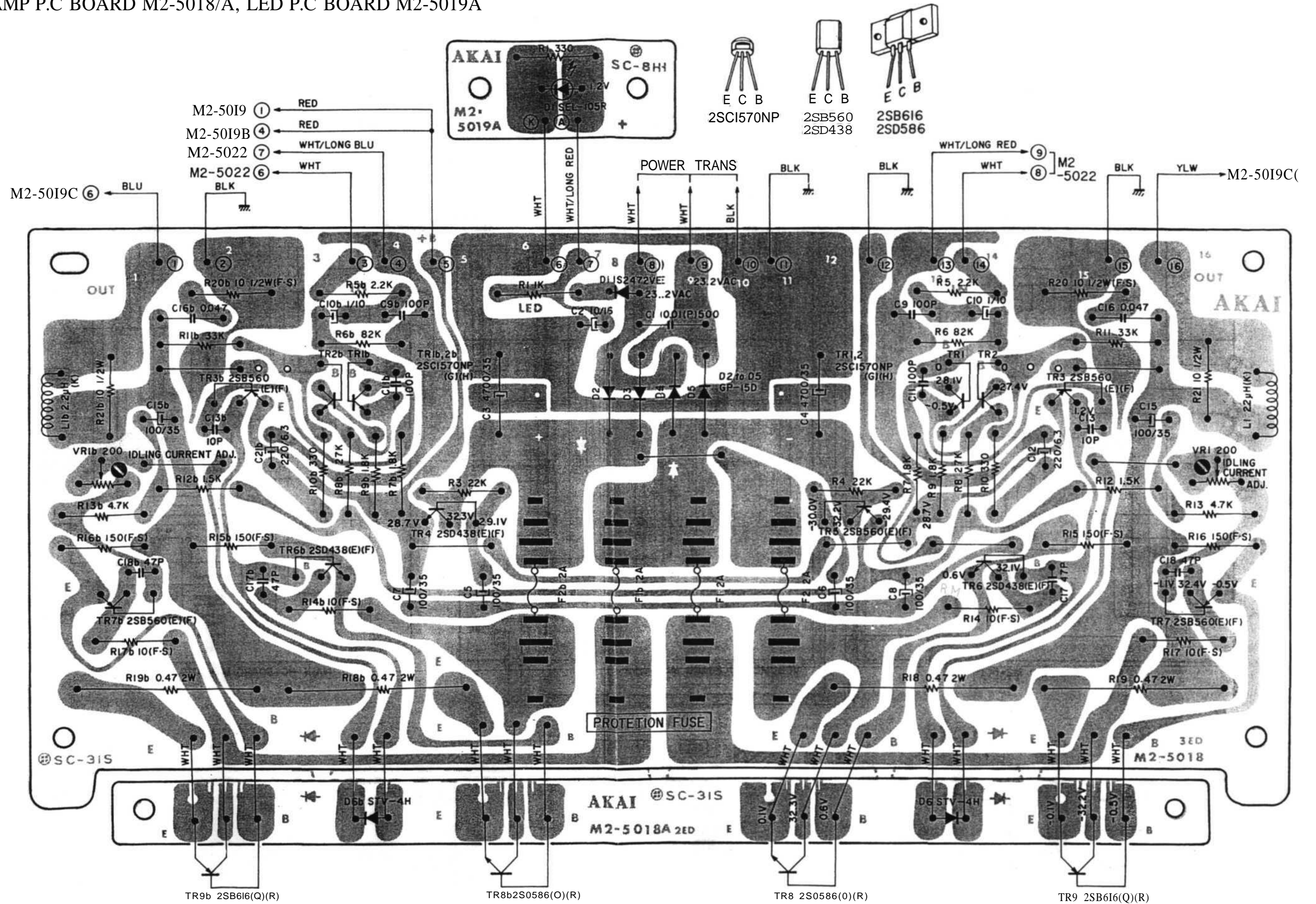

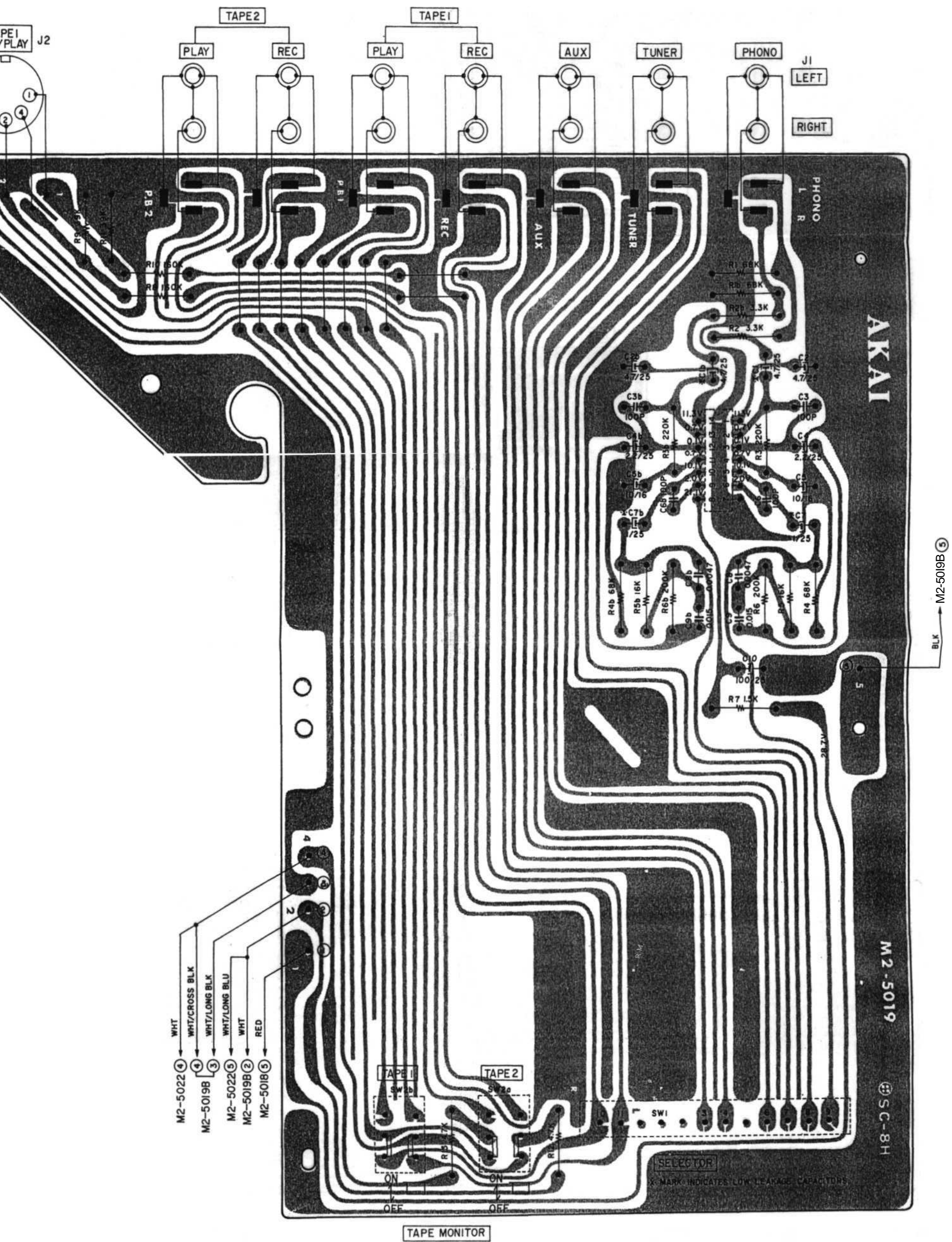

- M2-5022 ④ WHT
- M2-5019B ④ WHT/CROSS BLK
- M2-5019B ③ WHT/LONG BLK
- M2-5022 ⑤ WHT/LONG BLU
- M2-5019B ② WHT
- M2-5018 ⑤ RED

TAPE MONITOR

AKAI

M2-5019

SC-8H

SELECTOR
X-MARK INDICATES LOW LEAKAGE CAPACITORS

BLK M2-5019B ⑤

VR P.C BOARD'M2-5019B

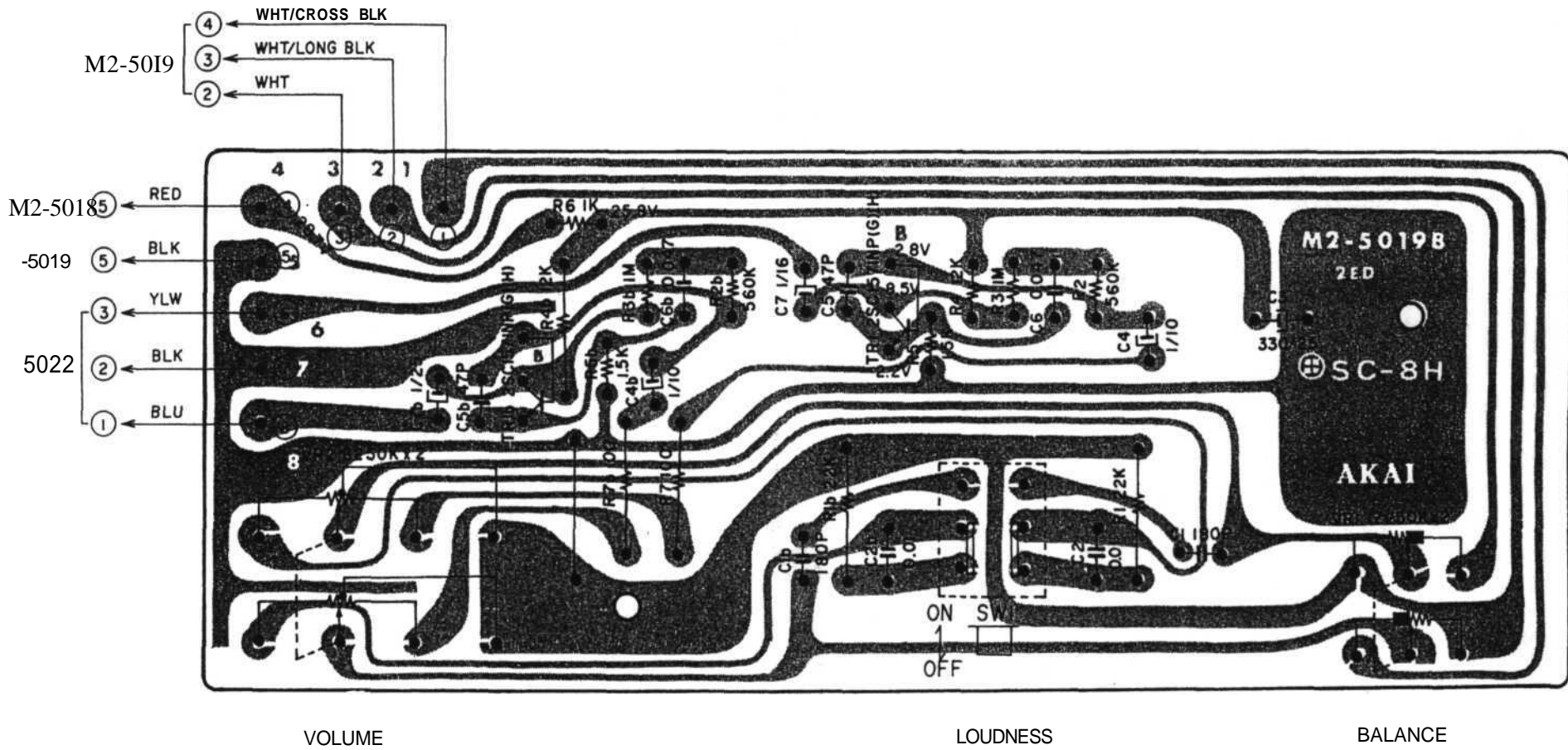

HEADPHONE P.C BOARD M2-5019C

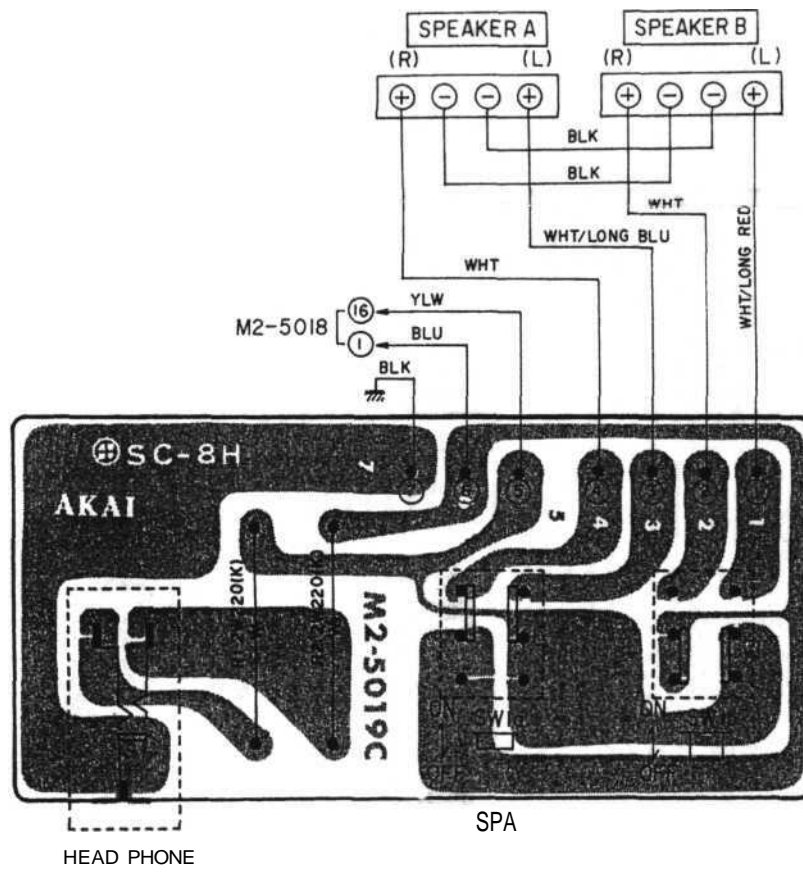

TONE CONTROL P.C BOARD M2-5022

